

TSUBAKI GRIPPER CHAIN

For form, fill, and vacuum seal wrapping applications



Lower maintenance costs
Increased uptime
Increased productivity

A formidable new force has taken hold of wrapping operations.

Get a Grip on Truly Profitable Performance

Discover the difference Tsubaki's high-quality base chain makes in your bottom line.

- Lower maintenance costs
- Increased uptime
- Increased productivity



All-Inclusive Sprocket Package

Precision-machined sprockets with cam (assembled) and special surface coating for M-TYPE gripper chain applications are available as design stock.





Our high-performance roller chain is now available with both conventional and innovative new side-swivel gripper attachments for form, fill, and vacuum seal applications.

M-TYPE: Enhanced Operation

Tsubaki gripper attachments feature reliable clamping mechanisms to ensure precise positioning. High-performance springs are designed to last more than 1 million cycles, even at high speeds. Our M-TYPE attachment's side-swivel design allows optimal material feed-through to ensure your lines run smoother.

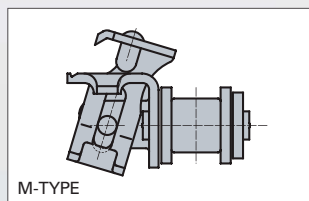

High-quality S-TYPE, L-TYPE, and BU-TYPE attachments, which open straight up and down, are also available.

Exclusive! Quickly Cut to Length

Tsubaki is the only manufacturer to offer Gripper Chain with recessed riveted pins for easy chain length adjustment. Keep production rolling with less downtime.



Industry-Leading Spring Design for Outstanding Grip Performance

Made possible by using the best combination of grip force, toughness, and accuracy.

Tsubaki Base Chain Options

Nickel Plated Chain

Nickel plating not only improves appearance but also gives the chain slight corrosion resistance. Therefore, it can be used in applications where there is exposure to water.

Nickel Plated Lambda Chain

Special oil-impregnated bushings deliver long life with no lubrication. The result is reduced labor maintenance, better operating environments, and greater productivity.

Stainless Steel Chain

Tsubaki stainless steel corrosion-resistant Gripper Chain is your solution for challenging environments. This chain combines proven design with wear-resistant hardened stainless steel components that extend service life and offer the highest load capacity of any Tsubaki stainless steel chain.

Special Surface Treated Chain (NEP)

This next-generation chain boasts the highest level of corrosion resistance among various plated and surface-treated chains and uses no toxic substances such as hexavalent chromium, thus reducing the impact on the environment.

Extended Service Life

Tsubaki original lubricant is applied at the factory following assembly to ensure uniform coverage and protection of each chain component.

Quick, Uniform Start-Up

Factory pre-loading minimizes initial chain elongation. Colored connecting links are easy to identify while in service and convenient to install with spring clips.

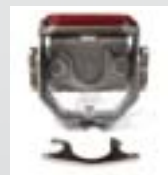

Applicable Industries

Food: Ham, Sausage, Cheese, Bread, etc.

Electric: Electric wiring, Globes, etc.

Medical: Syringes, Medicine, etc.



M-TYPE GRIPPER CHAIN

RS08B-NP-KUM and RS08B-LM-NP-KUM

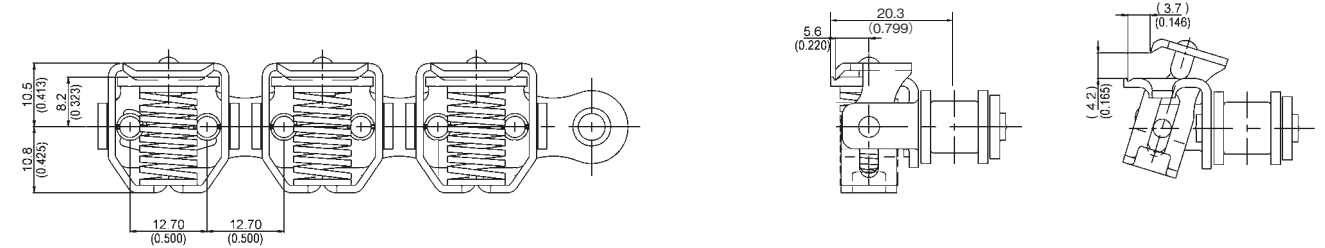

RS10B-NP-KUM and RS10B-LM-NP-KUM

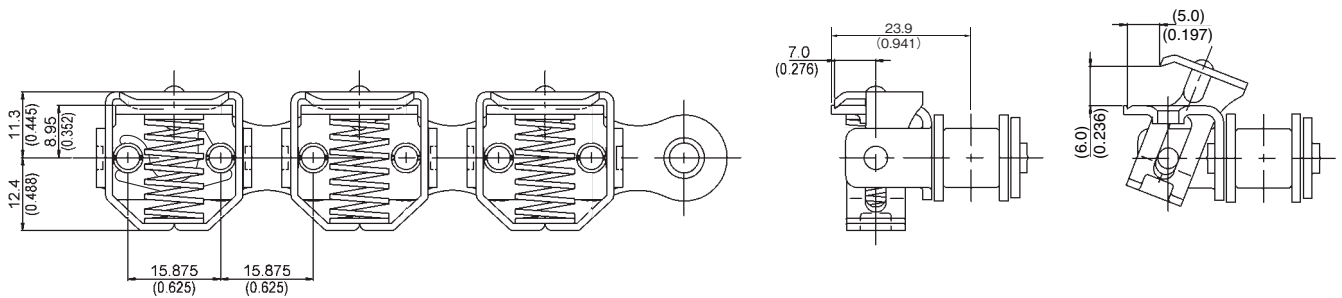

M-TYPE-SS GRIPPER CHAIN

RS10B-SS-KUM

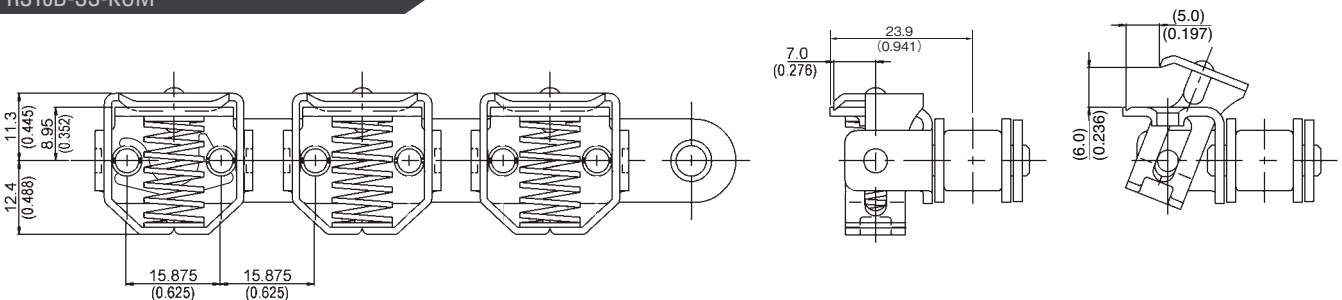

ISO Ref.	Tsubaki Chain Number	Connecting Link Number	Pitch		Roller Diameter		Inside Width		Clamp Type	Clamping Force	Materials		
			mm	Inches	mm	Inches	mm	Inches			N	Base Chain	Clamp
08B-1	RS08B-NP-KUM	RS08B-NP-KUM-CL	12.70	.500	8.51	.335	7.75	.305	Type M	50	NP	SS	SA
08B-1	RS08B-LM-NP-KUM	RS08B-LM-NP-KUM-CL	12.70	.500	8.51	.335	7.75	.305	Type M	50	NP Lambda	SS	SA
10B-1	RS10B-NP-KUM	RS10B-NP-KUM-CL	15.875	.625	10.16	.400	9.65	.380	Type M	70	NP	SS	SA
10B-1	RS10B-LM-NP-KUM	RS10B-LM-NP-KUM-CL	15.875	.625	10.16	.400	9.65	.380	Type M	70	NP Lambda	SS	SA
10B-1	RS10B-SS-KUM	RS10B-SS-KUM-CL	15.875	.625	10.16	.400	9.65	.380	Type M	70	SS	SS	SS

NP = Nickel Plated Steel SS = Stainless Steel SA = Special Alloy Note: Do not twist chain. Use care not to damage attachments when unwinding chain from reel.



S-TYPE GRIPPER CHAIN

RS08B-NP-KUS and RS08B-LM-NP-KUS

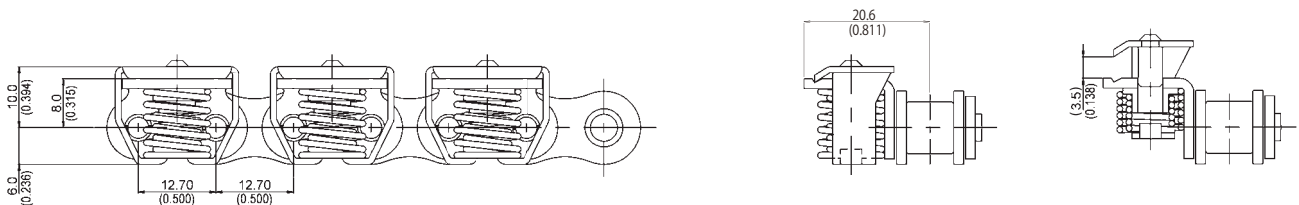

L-TYPE GRIPPER CHAIN

RS08B-NP-KUL and RS08B-LM-NP-KUL

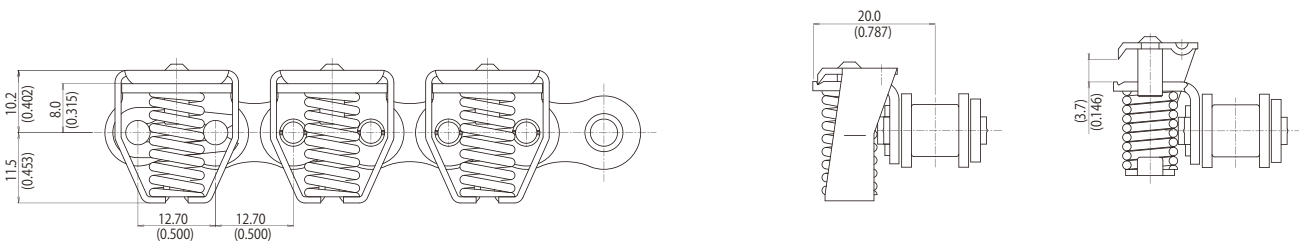

BU-TYPE GRIPPER CHAIN

RS10B-NP-KU-BU and RS10B-LM-NP-KU-BU

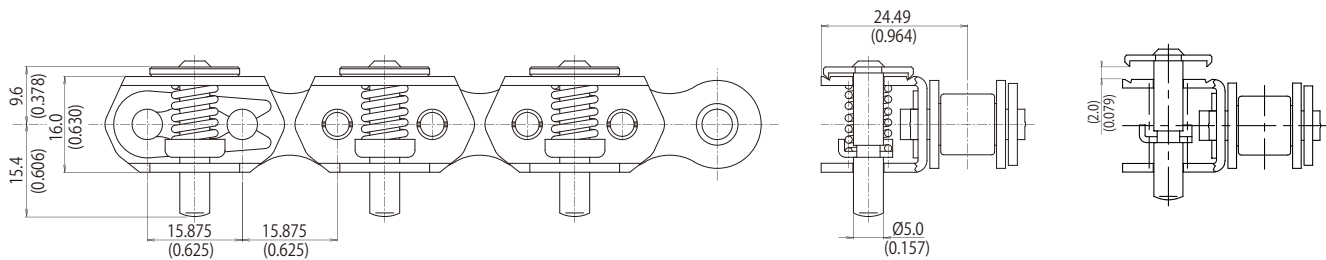

ISO Ref.	Tsubaki Chain Number	Connecting Link Number	Pitch		Roller Diameter		Inside Width		Clamp Type	Clamping Force	Materials		
			mm	Inches	mm	Inches	mm	Inches			Base Chain	Clamp	Spring
08B-1	RS08B-NP-KUS	RS08B-NP-KUS-CL	12.70	.500	8.51	.335	7.75	.305	Standard	55	NP	SS	SA
08B-1	RS08B-LM-NP-KUS	RS08B-LM-NP-KUS-CL	12.70	.500	8.51	.335	7.75	.305	Standard	55	NP Lambda	SS	SA
08B-1	RS08B-NP-KUL	RS08B-NP-KUL-CL	12.70	.500	8.51	.335	7.75	.305	Long	80	NP	SS	SA
08B-1	RS08B-LM-NP-KUL	RS08B-LM-NP-KUL-CL	12.70	.500	8.51	.335	7.75	.305	Long	80	NP Lambda	SS	SA
10B-1	RS10B-NP-KU-BU	RS10B-NP-KU-BU-CL	15.875	.625	10.16	.400	9.65	.380	Button	60	NP	—	SS
10B-1	RS10B-LM-NP-KU-BU	RS10B-LM-NP-KU-BU-CL	15.875	.625	10.16	.400	9.65	.380	Button	60	NP Lambda	—	SS

NP = Nickel Plated Steel SS = Stainless Steel SA = Special Alloy Note: Do not twist chain. Use care not to damage attachments when unwinding chain from reel.



TSUBAKIMOTO CHAIN CO.

Headquarters

Nakanoshima Mitsui Building 3-3-3 Nakanoshima, Kita-ku Osaka 530-0005, Japan
Phone : +81-6-6441-0011 Facsimile : +81-6-6441-0489 Internet : <http://tsubakimoto.com/>

Chain & Power Transmission Operations Chain Products Department

1-3 Kannabidai 1-chome Kyotanabe, Kyoto 610-0380, Japan
Phone : +81-774-64-5100 Facsimile : +81-774-64-5212

Global Associated Partners:

NORTH and SOUTH AMERICA

U.S. TSUBAKI POWER TRANSMISSION, LLC

301 E. Marquardt Drive, Wheeling, IL 60090-6497, U.S.A.
Phone : +1-847-459-9500
Facsimile : +1-847-459-9515

TSUBAKI of CANADA LIMITED

1630 Drew Road, Mississauga, Ontario L5S 1J6, Canada
Phone : +1-905-676-0400
Facsimile : +1-905-676-0904

TSUBAKI BRASIL EQUIPAMENTOS INDUSTRIAIS LTDA.

Rua Pamplona, 1018 - C.J. 73/74, Jardim Paulista
CEP 01405-001, São Paulo - S.P. Brazil
Phone : +55-11-3253-6656
Facsimile : +55-11-3253-3384

EUROPE

TSUBAKIMOTO EUROPE B.V.

Aventurijn 1200, 3316 LB Dordrecht, The Netherlands
Phone : +31-78-6204000
Facsimile : +31-78-6204001

TSUBAKIMOTO U.K. LTD.

Osier Drive, Sherwood Park, Annesley, Nottingham
NG15 0DX U.K.
Phone : +44-1623-688-700
Facsimile : +44-1623-688-789

TSUBAKI DEUTSCHLAND GmbH

ASTO Park Oberpfaffenhofen, Friedrichshafener Straße 1
D-82205 Gilching, Germany
Phone : +49-8105-7307100
Facsimile : +49-8105-7307101

TSUBAKI KABELSCHLEPP (RUSSIA)

Prospekt Andropova 18 Building 6 115432 Moscow, Russia
Phone : +7-499-4180212
Facsimile : +7-499-4180212

ASIA and OCEANIA

TAIWAN TSUBAKIMOTO CO.

No. 33, Lane 17, Zihciang North Road
Gueishan Township, Taoyuan County, Taiwan
Phone : +886-33-293827/8/9
Facsimile : +886-33-293065

TSUBAKIMOTO CHAIN TRADING (SHANGHAI) CO., LTD.

Room 601, Urban City Centre, 45 Nanchang Road
Huangpu District, Shanghai 200020, People's Republic of China
Phone : +86-21-5396-6651/2
Facsimile : +86-21-5396-6628

TSUBAKIMOTO CHAIN CO. KOREA OFFICE

#1401, West Wing, Hanshin Intervalley 24, 707-34
Yeoksam 2(i)-dong, Gangnam-gu, Seoul, Korea
Phone : +82-2-2183-0311
Facsimile : +82-2-2183-0314

TSUBAKIMOTO SINGAPORE PTE. LTD.

25 Gul Lane, Jurong, Singapore 629419
Phone : +65-6861-0422/3/4
Facsimile : +65-6861-7035

TSUBAKIMOTO SINGAPORE PTE. LTD.

VIETNAM REPRESENTATIVE OFFICE
8F H&H Building, 209 Hoang Van Thu
Phu Nhuan District, Ho Chi Minh City, Vietnam
Phone : +84-8-3999-0131 or 0132
Facsimile : +84-8-3999-0130

TSUBAKIMOTO (THAILAND) CO., LTD.

388 Exchange Tower, 19th Floor, Unit 1902
Sukhumvit Road, Klongtoey, Bangkok 10110, Thailand
Phone : +66-2-262-0667
Facsimile : +66-2-262-0670

TSUBAKI INDIA POWER TRANSMISSION PTE. LTD.

Chandrika Chambers No.4, 3rd Floor, Anthony Street,
Royapettah, Chennai-600014, Tamil Nadu, India
Phone : +91-44-4231-5251
Facsimile : +91-44-4231-5253

PT. TSUBAKI INDONESIA TRADING

Wisma 46 - Kota BNI, 24th Floor, Suite 24.15
Jl. Jend. Sudirman, Kav. 1 Jakarta 10220, Indonesia
Phone : +62-21-571-4230/1
Facsimile : +62-21-571-4232

TSUBAKI POWER TRANSMISSION (MALAYSIA) SDN. BHD.

No. 22, Jalan Astaka U8/84A, Bukit Jelutong Industrial Park,
Section U8, 40150 Shah Alam, Selangor, Malaysia
Phone : +60-3-7859-8585
Facsimile : +60-3-7859-7575

TSUBAKI AUSTRALIA PTY. LTD.

Unit E, 95-101 Silverwater Road
Silverwater, N.S.W. 2128, Australia
Phone : +61-2-9704-2500
Facsimile : +61-2-9704-2550

TSUBAKI AUSTRALIA PTY LIMITED

NEW ZEALAND BRANCH
2 Kalmia Street, Ellerslie, Auckland 1051, New Zealand
Phone : +64-275-082-726
Facsimile :

Distributed by: